



10' x 10' **EMPEROR**
CABANA 

I N S T R U C T I O N M A N U A L









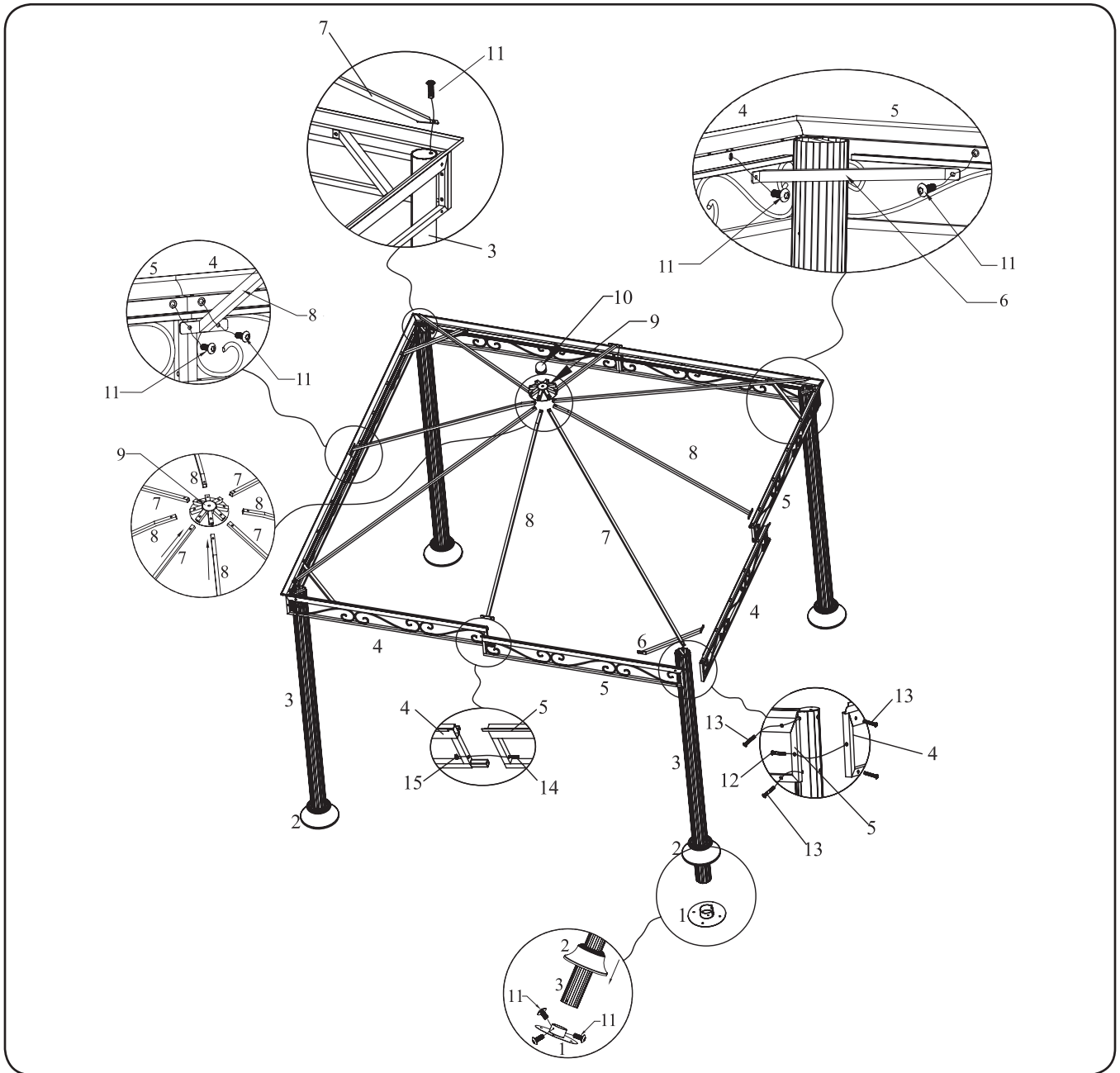













CARAVAN[®]
instant
canopies

14600 Alondra Blvd.
La Mirada, CA 90638
877-9-CANOPY
714-367-3000
Fax 714-367-3050
www.caravancanopy.com

ASSEMBLY DIAGRAM & PARTS LIST



Part	Name	Image	Qty
1	Foot Plate		4
2	Foot Plate Cover		4
3	Leg Post		4
4	Left Crossbar		4
5	Right Crossbar		4
6	Corner Brace		4
7	Long Rib		4
8	Short Rib		4
9	Center Peak		1
10	Peak Crown		1

Part	Name	Image	Qty
11	Small Screw		32
12	Medium Screw		4
13	Long Screw		16
14	Extra Long Screw		4
15	Nut		4
16	Ground Stake		16
17	Allen Wrench		1
18	Wrench		1
19	Roof Cover		1
20	Mosquito Net		1

EMPEROR CABANA SET UP INSTRUCTIONS

Warning! Please Read - Immediately!

- This Cabana is manufactured to provide maximum protection from the sun.
- Do not leave Cabana top on in any wind, rain, snow or inclement weather conditions.
- Do not use open flame under or near Cabana.
- Do not hang materials or objects on or from Cabana.

Tools Needed To Assemble:

- Cordless Drill/Screwdriver
- Ladder

Important:

- Do not remove numbered stickers until set up is complete.
- Requires a minimum of 3 people to assist with assembly

BASE ASSEMBLY

Step #1

Attach foot plate – part # 1 – onto leg post – part # 3 – (pic #1A) and secure with small screws (pic #1B). Repeat this process on all four posts.

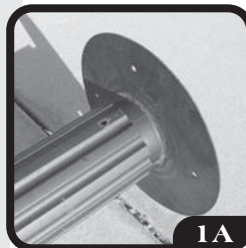

1A

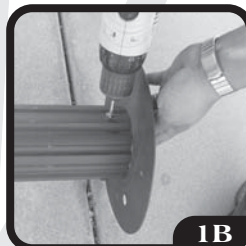

1B

Step #2

Place foot plate cover – part # 2 – over leg post – part # 3 – and secure (pic #2). Repeat this process on all four posts.



2

Step #3

Attach left cross bars – part # 4 – to right cross bars – part # 5 (pic #3A) and secure with extra long screws and nuts (pic #3B). Repeat this process for all four sides of the Cabana.

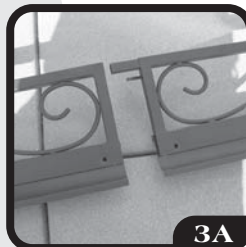

3A

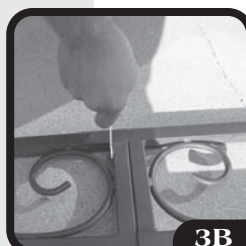

3B

Step #4

Lift all connected cross bars (4) up onto the leg posts (pic #4A). Secure cross bars to leg posts with long screws (pic #4B) and the cross bars together with medium screws (pic #4C). Repeat this process on all four posts.



4A



4B



4C

Step #5

Attach the corner brace – part # 6 – in the corner of the Cabana connected to the cross bars (pic #5) of the Cabana and secure with small screws. Repeat this process on all four corners.



5

CONTINUED ON NEXT PAGE...>

ROOF & FRAME ASSEMBLY

Step #1

Insert the connected long rib extension – part # 7 – into center peak – part # 9 – with push pins (pic #1).



Step #2

Connect short rib ceiling bars (4) – part # 8 – into center peak – part # 9 – with push pins (pic #2).



Step #3

Lift assembled ceiling structure onto base frame assembly (pic #3A). Attach and secure long rib extensions – part # 7 to top of leg posts and secure with small screws (pic #3B). Repeat this process on all four corners.

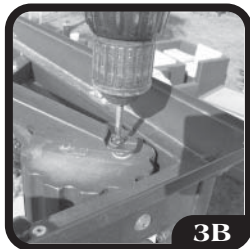

Step #4

Attach short rib ceiling bars – part # 8 - onto the midpoint of the crossbars and secure with small screws (pic. #4).



Step #5

Drape the roof cover - part # 19 - over the ceiling frame structure (pic #5) and secure and tighten to the four corners of the frame. (Refer to Step #7 for securing instructions)



Step #6

Place the peak crown - part # 10 through the hole in the center of the top opening of the ceiling fabric and secure into center peak - part # 9 (pic #6).



Step #7

Secure ceiling fabric to frame buttons by twisting in place (pic #7).



Step #8

Secure fabric valances in the corners and midpoint of the frame with Velcro® (pic #8A & 8B).



Step #9

Attach mosquito net - part # 20 - through the grommets onto the crossbar hooks (pic #9). Extend curtains with netting and secure at each corner post with the (Velcro®) straps.



(Please note: center of fabric curtains are to be placed at the corner of Cabana where the leg posts are located. These are meant to be corner curtains.)

Step #10

Your Emperor Cabana is now assembled for your enjoyment (pic #10).



CARAVAN® 1-YEAR LIMITED WARRANTY

Caravan® Canopy Int'l warrants that each part of this product and the product itself will be free from defects in material and workmanship for twelve (12) months from date of purchase. This warranty is void if: (A) Product is used under other than normal use and maintenance conditions. (B) Product is modified or altered. (C) Product is subject to abuse or neglect. (D) Product damage is accidental or deliberate or caused by rain, wind or other forces of nature. (E) Product use does not conform to product instructions. (F) Product is repaired by someone other than Caravan® Canopy Int'l or its authorized representative.

The manufacturer's obligation is limited to replacing or repairing such defects during the warranty period at no charge.

If service is required, do not return the product to the store. Please contact Caravan® Canopy Int'l for specific shipping instructions before returning any part. All shipping costs must be pre-paid. A purchase receipt or other proof of purchase is required before warranty service is rendered. Caravan® Canopy Int'l will not be responsible for any products damaged in transit.

For a warranty claim call 877-9-CANOPY. Most service problems are resolved by replacing a broken or defective part. If this is not the case, we will give you instructions for returning the product. Return products to: Caravan® Canopy International Inc., 14600 Alondra Blvd., La Mirada, CA 90638 USA

After inspection, warranted products will be returned at no cost. If it is determined that products are not a warranty issue, it is the customer's responsibility to pay for repair and/or replacement parts and return shipping costs. If a problem with your canopy develops after the warranty period, please contact Caravan® Canopy Int'l for service. 877-9-CANOPY.

Under no circumstances will the retail customer, user, authorized representative or other person be entitled to any direct, special, indirect, consequential or exemplary damages for breach of contract or otherwise. Under no circumstances will any person be entitled to a sum greater than purchase price of the malfunctioning part.

No Caravan® Canopy Int'l authorized representative or person other than an officer of Caravan® Canopy Int'l may extend or modify this warranty. There are no other warranties from either Caravan® Canopy Int'l or its representatives which extend the face of this warranty. All other warranties, expressed or implied, including the warranties of merchantability, fitness for a particular purpose and fitness for use are excluded. See www.caravancanopy.com for further details.



14600 Alondra Blvd., La Mirada, CA 90638 USA
877-9-CANOPY • 716-367-3000 • Fax 714-367-3050
www.caravancanopy.com