

 **MATTHEWS™**
FOUR SEASONS
A Garden of Quality Products

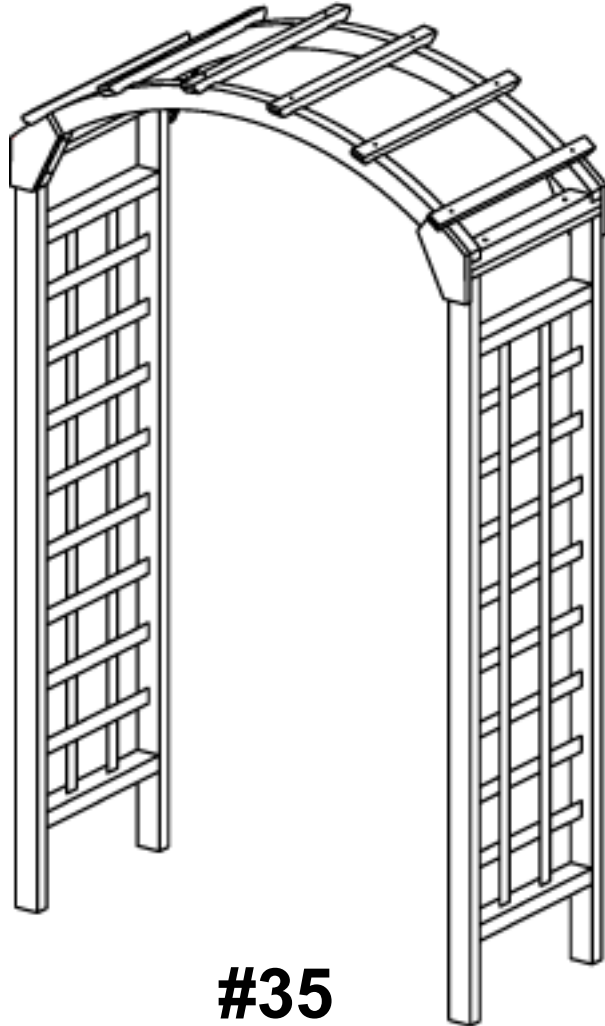

#35

CONGRATULATIONS!

You have just purchased a quality garden product from *Matthews Four Seasons™*. Please examine the contents of your package carefully before assembly. If any parts are missing, **DO NOT RETURN THIS PRODUCT OR CALL THE RETAILER.** Please contact *Matthews Four Seasons™* directly at
1-800-755-1757

6677 East Hardaway Road, Stockton, California 95215
www.matthewsfourseasons.com

#35 ARBOR PARTS LIST

Item #	Description	Qty	Part No.
(A)	LEG FRAME ASSEMBLY	2	35-240
(B)	TOP RAIL	2	35-260
(C)	TOP RAIL CLEAT - CENTER	4	35-261
(D)	TOP RAIL CLEAT - OUTER	2	35-262
(E)	TOP RAIL SUPPORT	2	35-245
(F)	CORNER SUPPORT - LEFT HAND	2	35-263
(G)	CORNER SUPPORT - RIGHT HAND	2	35-264
(AB)	WOOD SCREW - 1-1/2" - (STEP *4)	8	991707
(AC)	MACHINE BOLT - 2-3/8" - (STEP *3)	4	991733
(AD)	WOOD SCREW - 2" - (STEPS *1 & *2)	16	991719
(AE)	"T" NUT - INSTALLED AT FACTORY	4	991711

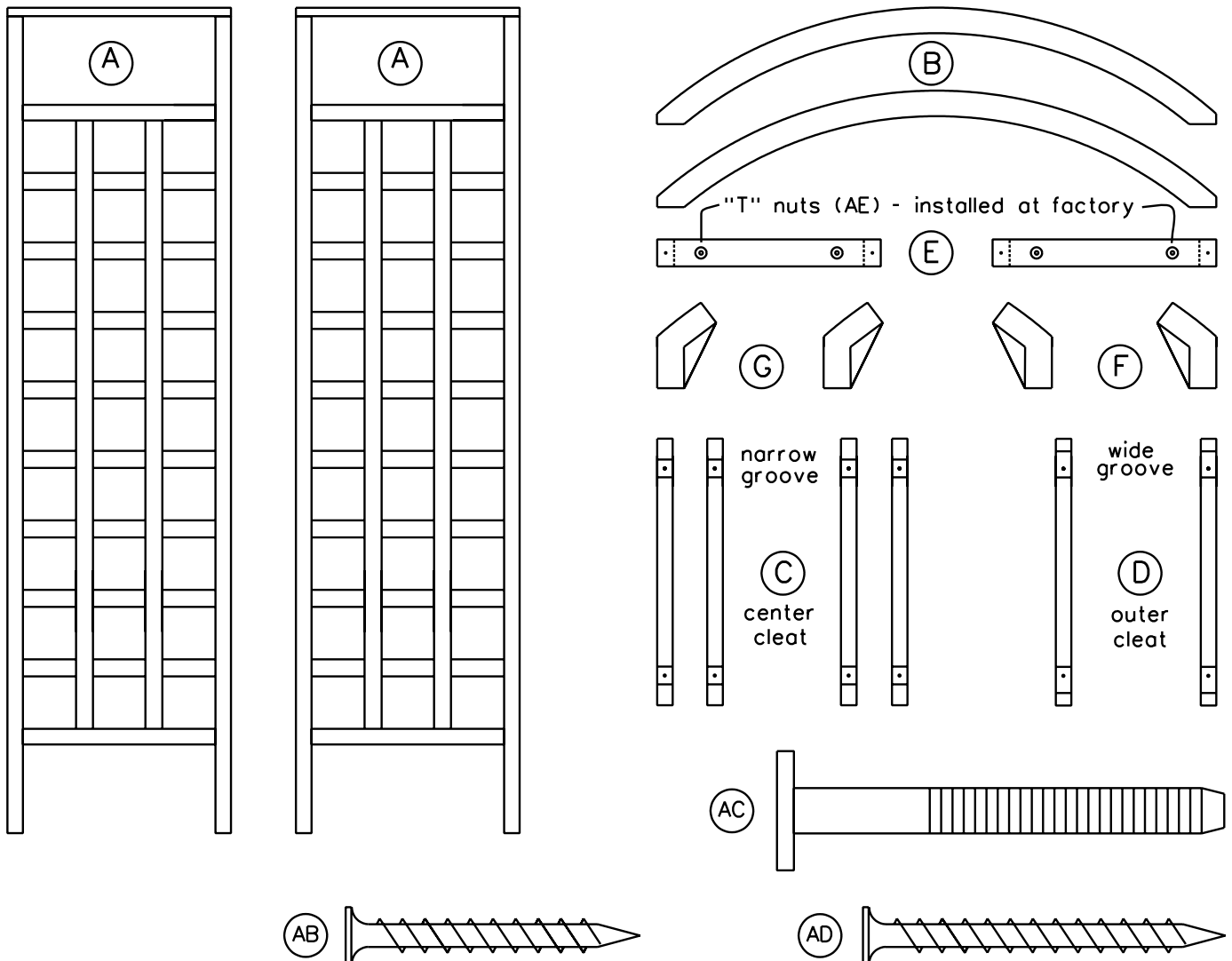

#1 Attach Top Rail Support (E) to Top Rail (B)

- ① Position a Top Rail (B) as shown - Finished side down - Staple side up!
- ② Attach the Top Rail Supports (E) to the Top Rail (B) using 2 - 2" wood screws (AD).
- ③ Attach the other Top Rail (B) in the same manner.

Be sure that the Top Rail Support is square to the Top Rail before tightening the screws.

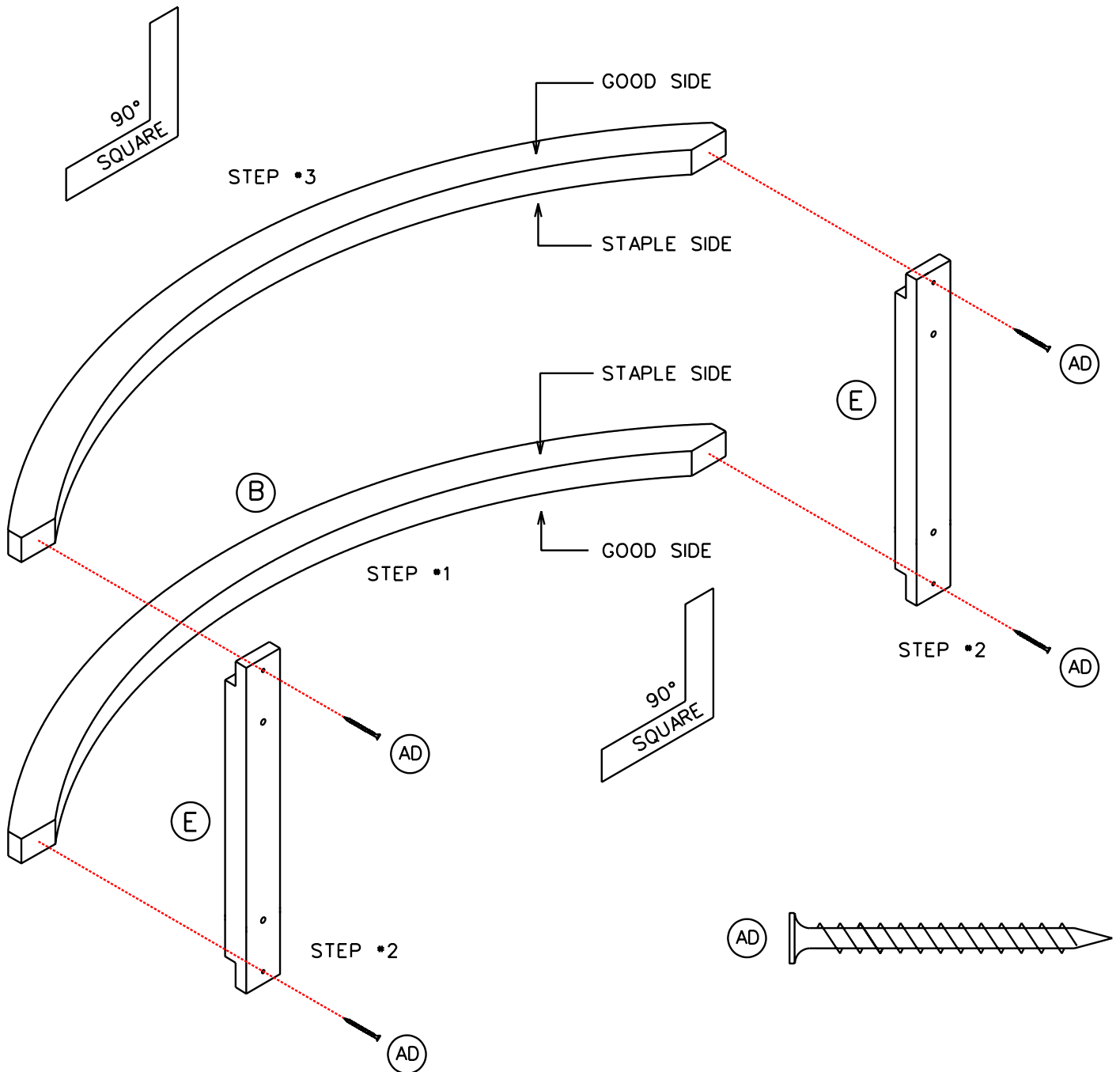

#2 Attach Cleats (C & D) to Top Rail Assembly

- ① Position the Top Rail Assembly from Step #1 as shown.
- ② Attach the 4 Center Cleats (C) and 2 Outer Cleats (D) using 12 2" wood screws (AD).

Pilot holes have been provided in the Top Rails and grooves in the Cleats to locate the parts.

Be sure that you position the Outer Cleats (D) as shown

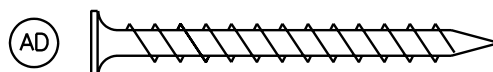
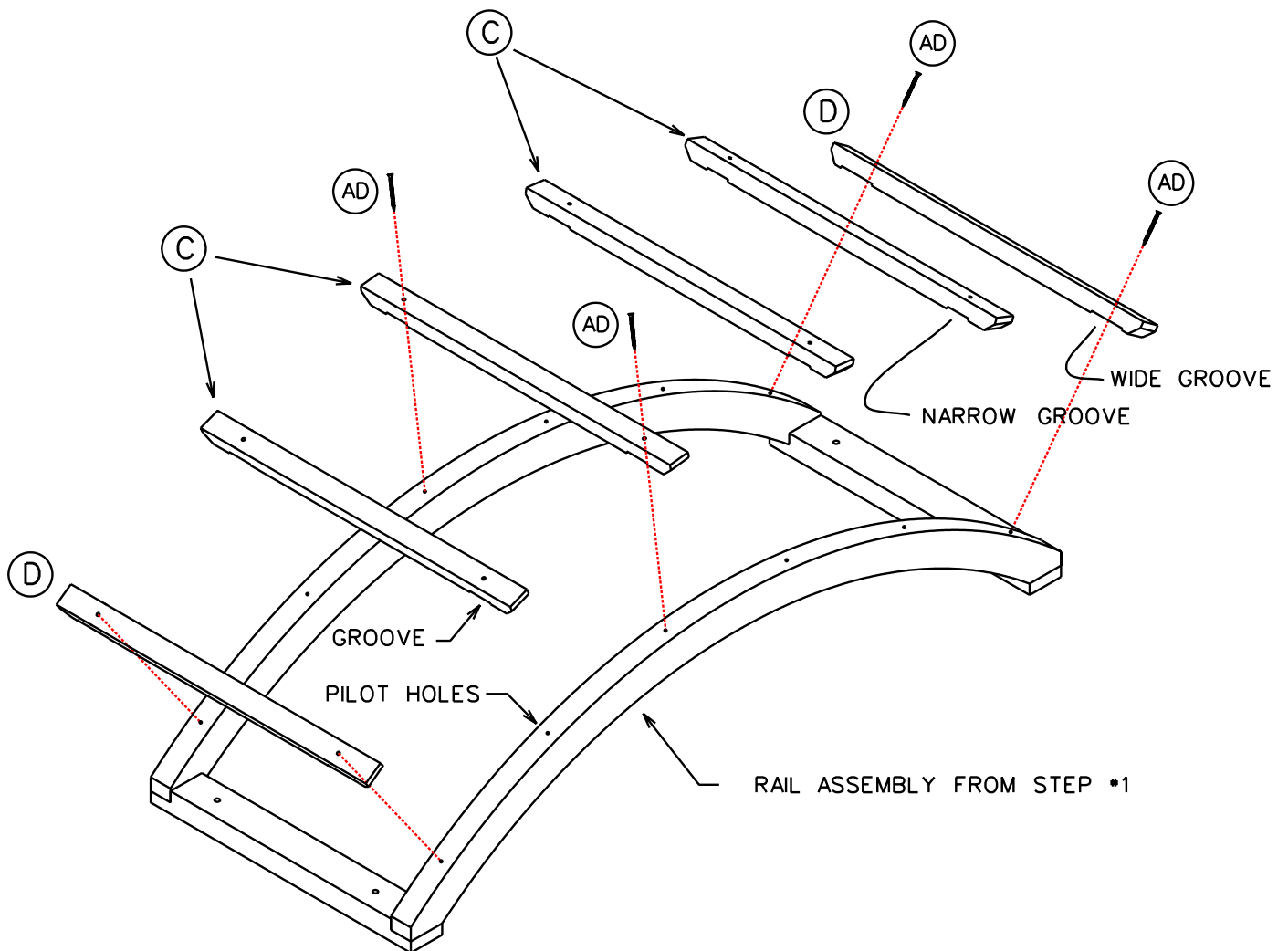

#3 Attach Upper Assembly to Leg Frames (A)

- ① Position the Upper Assembly and Leg Frames Assemblies (A) as shown.
- ② Secure the Upper Assembly to the Leg Frames using 4 Machine Bolts (AC).

"T" Nuts have been installed at the factory for easier assembly

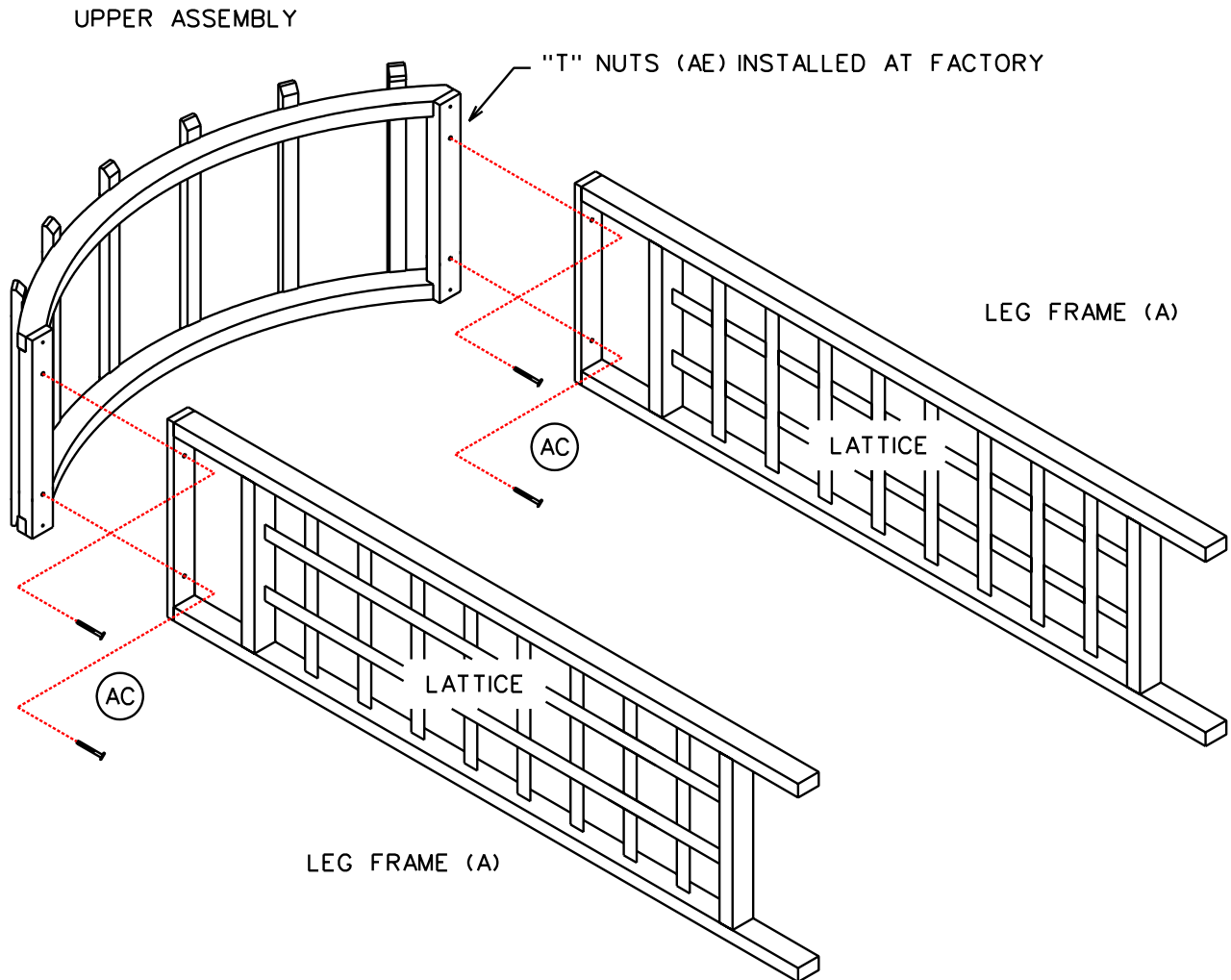

NOTE: BE SURE THAT THE LATTICE IS POSITIONED AS SHOWN

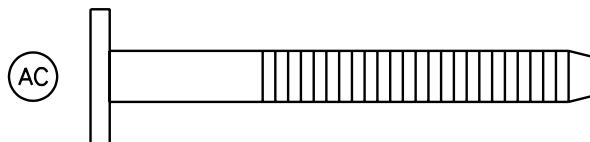

#4 Attach the LH (F) & RH (G) Corner Supports

- ① Attach the LH Corner Support (F) using 2 wood screws (AB).
Be sure that the support is tight against the Top Rail and Leg.
- ② Attach the other Corner Supports in the same manner.

